

ICBSO30TM/S/TH



FEATURES

Advanced Dual VertiCross convection system for faster preheats and consistent cooking across all racks

Gourmet feature has menu of presets that automatically controls cooking of popular meals

Interactive color touchscreen for advanced cooking control

Can be installed flush with surrounding cabinetry for integrated look

Enhanced interior views with triple-pane glass and three halogen lights

145 L capacity to handle multiple dishes at once

10 cooking modes for predictably delicious results (Convection, Roast, Bake, Grill, Convection Roast, Stone, Gourmet, Warm, Proof and Dehydrate)

ACCESSORIES

30" Broiler Pan

Accessories available through an authorized dealer.

For local dealer information, visit subzero-wolf.com/locator.



PRODUCT SPECIFICATIONS

Model	ICBSO30TM/S/TH
Dimensions	759mmW x 724mmH x 584mmD
Oven 1 Interior Dimensions	641mmW x 448mmH x 506mmD
Overall Capacity	145 L
Door Clearance	543mm
Weight	124 kg
Electrical Supply	220-240 VAC; 50/60 Hz
Electrical Service	4.2-4.8 kW

ELECTRICAL

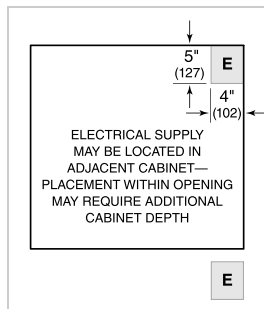

NOTE: Dimensions in parenthesis are in millimeters unless otherwise specified

DIMENSIONS

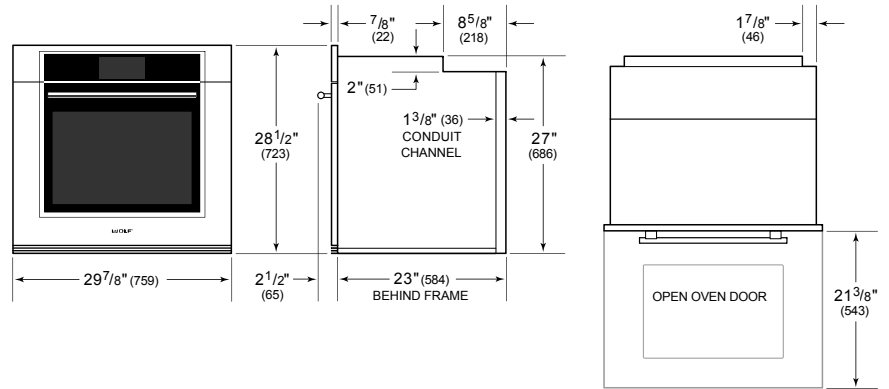

STANDARD INSTALLATION

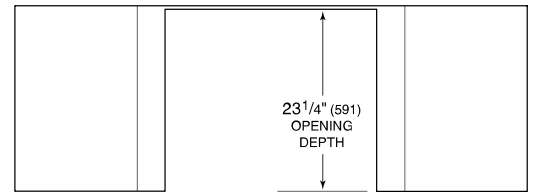

TOP VIEW

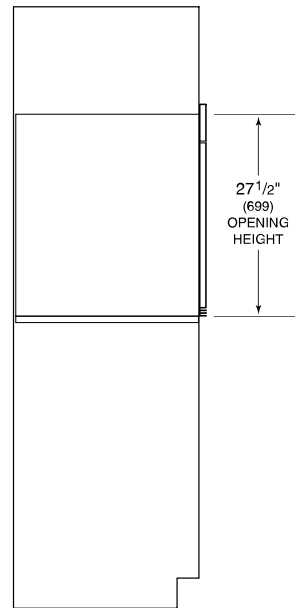

SIDE VIEW

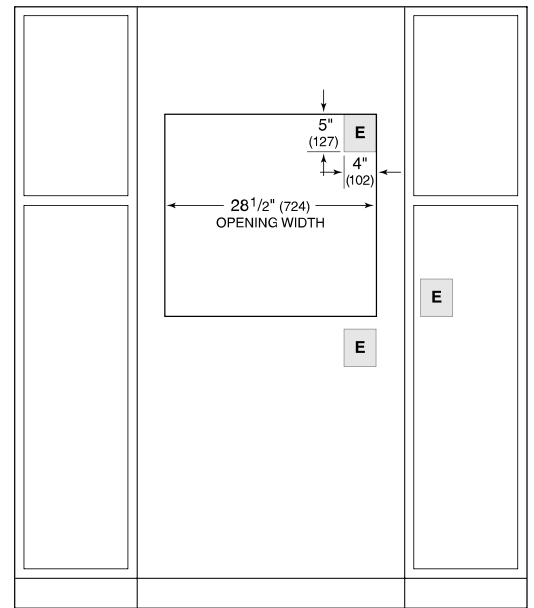

FRONT VIEW

NOTE: Location of electrical supply within opening may require additional cabinet depth.